

BRAUN

8595 



ActiVator™

www.braun.com

Type 5643

5-643-450/00/1/-03/G2
D/GB/F/E/P/1/NL/DK/N/S/FIN/TR/GR
Printed in Germany



Braun Infoline

Deutsch	4, 10, 96
English	11, 17, 96
Français	18, 24, 96
Español	25, 31, 96
Português	32, 38, 96
Italiano	39, 45, 96
Nederlands	46, 52, 96
Dansk	53, 59, 96
Norsk	60, 66, 96
Svenska	67, 73, 96
Suomi	74, 80, 96
Türkçe	81, 96
Ελληνικά	88, 95, 96

- (D)** Haben Sie Fragen zu diesem Produkt?
- (A)** Rufen Sie an (gebührenfrei):
00 800 27 28 64 63
00 800 BRAUNINFOLINE
- (CH)** **08 44 - 88 40 10**
- (E)** Servicio al consumidor para España:
901-11 61 84
- (P)** Serviço ao Consumidor para Portugal:
808 20 00 33
- (I)** Servizio consumatori:
(02) 6 67 86 23
- (NL)** Heeft u vragen over dit produkt?
Bel Braun Consumenten-infolijn:
(070) 4 13 16 58
- (B)** Vous avez des questions sur ce produit ?
Appelez Braun Belgique
(02) 711 92 11
- (DK)** Har du spørgsmål om produktet? Så ring
70 15 00 13
- (N)** Spørsmål om dette produktet? Ring
88 02 55 03
- (S)** Frågor om apparaten? Ring Kundservice
020 - 21 33 21
- (FIN)** Onko Sinulla kysyttävää tuotteesta? Soita
0203 77877
- (TR)** Müşteri Hizmetleri Merkezi:
0212 - 473 75 85

Activator 8595

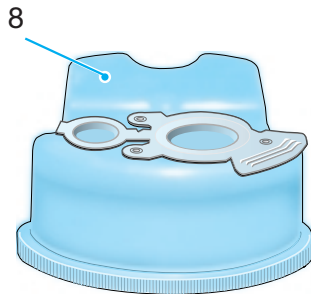
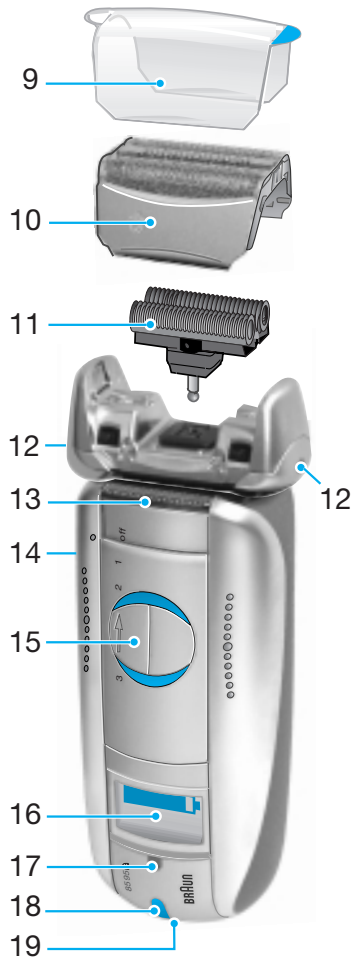
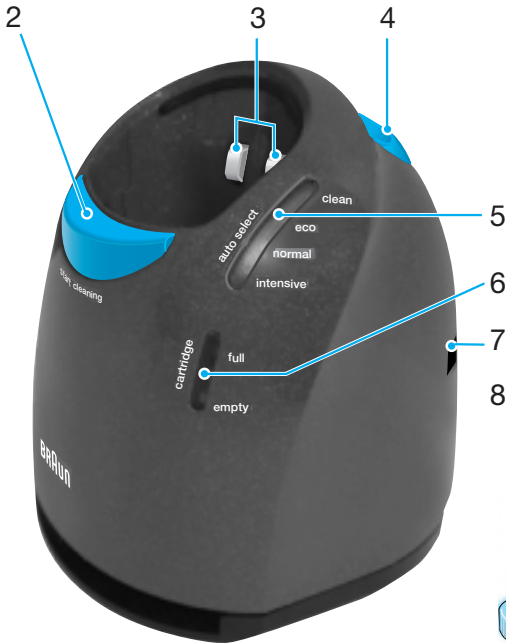

Your Activator (shaver with Clean&Charge station) is a system equipped with highly advanced electronic processors. It ensures unsurpassed closeness and comfort for you and optimum care for your shaver:

- The system automatically adapts to any voltage worldwide.
- The system recognizes when cleaning of your shaver is required, and automatically recognizes which of the three cleaning programs is appropriate.
- While the shaver is connected to the mains, the system automatically takes care of charging and discharging in a way that is optimized for the shaver's battery capacity and life span.
- The system takes care of lubrication of the shaver's cutting parts.
- The system tells you when to replace the shaving foil and cutter block.

Warning

Your Activator is provided with a low-voltage adapter. Therefore you must not exchange or manipulate any part of it. Otherwise there is risk of electric shock.

In order to avoid any leakage of the cleaning fluid, place the Clean&Charge station on a flat, stable surface.

Do not tip, move suddenly or transport the station in any way if a cleaning cartridge is installed. Do not place the station in a mirror cabinet, nor store it over radiators, nor place it on polished or laquered surfaces. Do not expose to direct sunlight. The station contains highly flammable liquid. Keep it away from sources of ignition. No smoking. Keep out of reach of children.

Do not refill cartridge.
Use only original Braun refill cartridge.

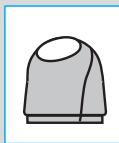
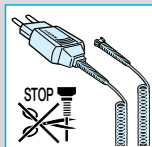

Description

1. Low-voltage adapter
2. «start cleaning» button
3. Station-to-shaver connecting contacts
4. Station lift button for cartridge exchange
5. Display for cleaning programs
6. Display for cleaning fluid status
7. Station mains socket
8. Cleaning cartridge
9. Shaver foil protection cap
10. Shaver foil
11. Cutter block
12. Foil release buttons
13. Long hair trimmer
14. Shaver-to-station connecting contacts (shaver backside)
15. Switch
16. Shaver display
17. Info key
18. Pilot light
19. Shaver mains socket

Before shaving

If you wish, you may start shaving right away (if the shaver is charged, see section «Shaver display»). However, we recommend to follow the procedure described here:

- Using the low-voltage adapter (1), connect the mains socket of the Clean&Charge station (7) to the mains.
- Press the station lift button (4) to open the housing.
- Hold the cleaning cartridge (8) down on a flat, stable surface (e.g. table).
- Carefully remove the lid from the cartridge.
- Slide the cartridge into the base of the station as far as it will go.
- Slowly close the housing by pushing it down until it locks.

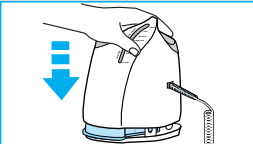
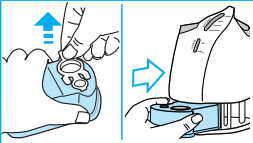
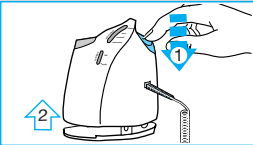
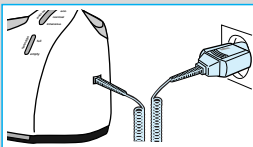

The display for cleaning fluid (6) will show how much cleaning fluid is in the cartridge:

- a) Cleaning solution sufficiently available
- b) Up to 7 cleanings left
- c) New cartridge required

Make sure the foil protection cap (9) is removed from the shaver. Insert the shaver head down into the station (the contacts on the back of the shaver (14) will correspond to the contacts in the station (3)). If necessary, the system will now charge the shaver.

Also, the cleaning status will be automatically analyzed and one of the four diodes of the cleaning program display (5) will light up:

- a) The shaver is clean
- b) Eco(nomic), i.e. short cleaning required
- c) Normal cleaning required
- d) Intensive cleaning required

If the system has selected one of the three cleaning programs, it will not start until you push down the «start cleaning» button (2). This locks the shaver into the station and starts the cleaning process.

We recommend cleaning after each shave.

While the cleaning is in progress, the respective cleaning program light will flash. Each cleaning consists of several cycles (where the cleaning fluid is flushed through the shaver head) and a heat drying period. The total cleaning time is 33 to 50 minutes.

Cleaning processes in the Clean&Charge should not be interrupted. While the shaver is drying, the metal parts of the shaver may be hot. Also, if the shaver is taken out prematurely and is not dry, its electronics could be harmed.

When the program is finished, the blue «clean» light will shine. You can release the shaver by pushing the «start cleaning» button.

Your shaver is now clean, charged and ready for use.

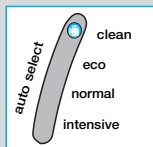
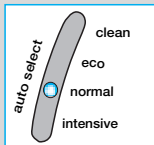
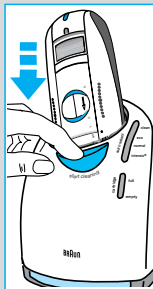
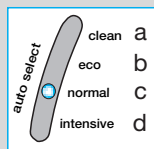
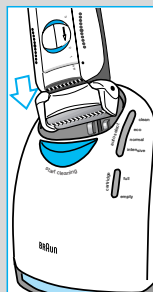
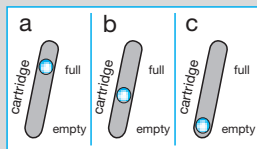

Shaving

If the shaver is locked into the Clean&Charge station, push the «start cleaning» button (2) to release the shaver and take it out.

Switch positions

off = (switch is locked)

Press and push up the switch to operate the shaver:

- 1 = Shaving with the pivoting head (the pivoting cutting system automatically adjusts to every contour of your face).
- 2 = Shaving with the pivoting head locked at an angle (to permit shaving in difficult areas, e.g. under the nose).
- 3 = The long hair trimmer is activated (for trimming sideburns, moustache and beard).

Tips for the perfect shave

We recommend that you shave before washing, as the skin tends to be slightly swollen after washing.

Hold the shaver at right angles (90°) to the skin.

Stretch your skin and shave against the direction of beard growth.

To maintain 100% shaving performance, replace your foil and cutter block when it is indicated on the shaver display or when the parts are worn or at least every 18 months.

Shaving with the cord

If the shaver is completely discharged (see section «Shaver display») and you do not have the time to recharge in the Clean&Charge station, you may also shave with the shaver connected to the mains via the low-voltage adapter.

After shaving

Automatic cleaning

After each shave, return the shaver to the Clean&Charge station and proceed as described above in the section «Before shaving». All charging and cleaning needs are then taken care of. With daily use, a cleaning cartridge should be sufficient for about 40 cleaning cycles.

The hygienic cleaning solution cartridge contains alcohol which, once opened, will naturally evaporate slowly into the surrounding air. Each cartridge, if not used daily, should be replaced after approximately 8 weeks.

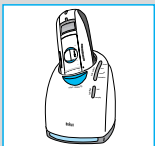
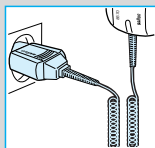
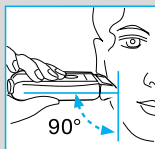
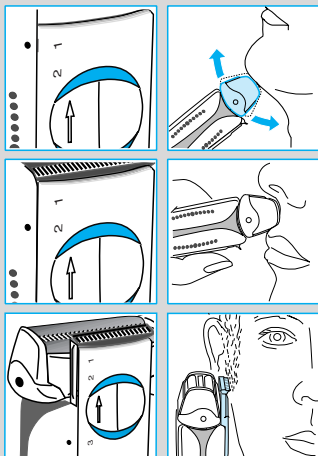

Quick cleaning

Press the foil release buttons (12) to lift the shaver foil (do not remove the foil completely). Switch on the shaver for approx. 5–10 seconds so that the shaved stubbles can fall out.

Thorough manual cleaning

Manual cleaning is recommended only when the Clean&Charge station is not available, e.g. when travelling. Never use water to clean the shaver.

Remove the shaver foil and tap it out on a flat surface. Using the brush, clean the cutter block and the inner area of the pivoting head. If you do not use the Clean&Charge station for a longer period of time, you should apply a drop of light machine oil onto the shaver foil.

Replacing the cartridge

After having pressed the lift button (4) to open the housing, wait for a few seconds before removing the used cartridge.

Before discarding the used cartridge, make sure to close the openings using the lid of the new cartridge, since the used cartridge will contain contaminated cleaning solution.

Cleaning the housing

Clean the housing of shaver and station from time to time with a damp cloth, especially inside the opening of the station where the shaver rests.

Shaver display

1. Pilot light: the shaver is connected to the mains.
2. Shaver is charging / Remaining charging time.
3. Self testing / shaver is fully charged (a full charge will give up to 50 minutes of cordless shaving time, depending on your beard growth).

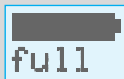
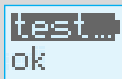
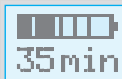
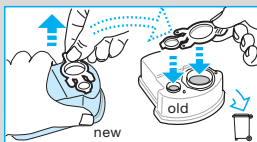
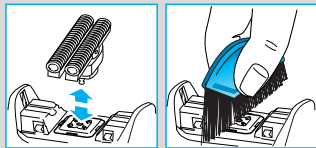
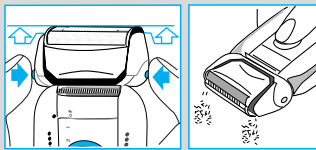

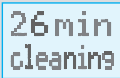

foil+cutter Part No.8000

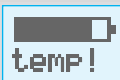

intensive clean needed

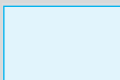

4. Remaining shaving time / Shaver must be charged.
5. Time left in the cleaning process.
6. Replace shaving foil and cutter block. To help obtain a new shaver foil and cutter block at your dealer or Braun Service Center, the display shows the part No. 8000. To reset the display, push the info key (17). We recommend to follow the display's suggestion, i.e. replace foil and cutter block every 18 months. Change both parts at the same time for a closer shave with less skin irritation.
7. System has initiated automatic battery maintenance (it is fully discharging and then recharging the batteries).
8. Environment temperature not suited for charging. Allow the shaver to remain for some time at room temperature for optimal charging conditions. Best environmental temperature range for charging is 15 °C to 35 °C.
9. Intensive cleaning needed – return to the Clean&Charge station as soon as possible. To reset the display, push the info key (17).
10. Info key, press once: duration of last shave. Press again: total number of shaves (cannot be reset). Press again: key part number for shaver foil and cutter block. Hold for 3 seconds: runs a display demo.
11. No display – shaver is completely discharged.

Accessories

Available at your dealer or Braun Service Centres:

- **Shaver foil and cutter block** No. 8000
- **Cleaning cartridge Clean&Charge CCR**

Environmental notice

This appliance is provided with nickel-hydride rechargeable batteries. To protect the environment, do not dispose of the appliance in the household waste at the end of its useful life. Open the housing as shown, remove and dispose of the batteries at your retail store or at appropriate collection sites according to national or local regulations.

The cartridge can be disposed with regular garbage.

Subject to change without notice.

This product conforms to the EMC-Directive 89/336/EEC and to the Low Voltage Regulation 73/23 EEC.

Electric specifications see printing on the housing.

Guarantee

We grant 2 years guarantee on the product commencing on the date of purchase. Within the guarantee period we will eliminate, free of charge, any defects in the appliance resulting from faults in materials or workmanship, either by repairing or replacing the complete appliance as we may choose.

This guarantee extends to every country where this appliance is supplied by Braun or its appointed distributor.

This guarantee does not cover: damage due to improper use, normal wear or use as well as defects that have a negligible effect on the value or operation of the appliance. The guarantee becomes void if repairs are undertaken by unauthorised persons and if original Braun parts are not used.

To obtain service within the guarantee period, hand in or send the complete appliance with your sales receipt to an authorised Braun Customer Service Centre.

For UK only:

This guarantee in no way affects your rights under statutory law.

