

**BRAUN**

**TASSIMO**<sup>®</sup>  
THE ART OF THE PERFECT CUP



**USER INSTRUCTIONS**

## Tassimo – The Art of the Perfect Cup

**Thank you for purchasing the Tassimo hot beverage machine. With Tassimo, you can now enjoy your favourite hot beverage any time. Rich filter coffee, intense espresso, delicate caffè crema, indulgent cappuccino, even hot chocolate\* and tea are yours at the touch of a button.**

The Tassimo machine is designed to work exclusively with special pods called Tassimo Discs (T-DISCS). T-DISCS contain precisely measured amounts of coffee, tea, chocolate\* and concentrated milk\*\*. The internal components of the T-DISC™ are uniquely tailored to each beverage and guide the flow through the Tassimo machine.

When you insert a T-DISC, the Tassimo machine reads the bar code printed on the label. This tells the machine exactly the size of drink, the brewing time and the precise temperature required to make your beverage. T-DISCS make a perfect team with the Tassimo machine and ensure exceptional beverage quality every single time, no matter what you choose to drink. T-DISCS are available in stores where you typically buy coffee.

Your package contains the following:

- Tassimo Machine
- Quick Start Card
- Cleaning Disc
- User Instructions
- Cleaning Tool
- Tassimo Registration Card



**Please read these instructions carefully and completely before using the appliance.**



\*Concentrated Hot Chocolate Flavour Drink \*\*Condensed partly skimmed milk

## The Tassimo machine

- A** Water container
- B** Clamp
- C** Brew mechanism
  - C1 - T-DISC holder
  - C2 - Piercing unit
  - C3 - Bar code reading window
- D** Adjustable cup stand
- E** Drip tray
- F** Splashback
- G** Start/Stop button
- H** Indicator lights:
  - AUTO
  - MANUAL
  - HEATING
  - STANDBY
- I** On/Off switch (on the back)
- J** Cleaning tool
- K** Cleaning disc

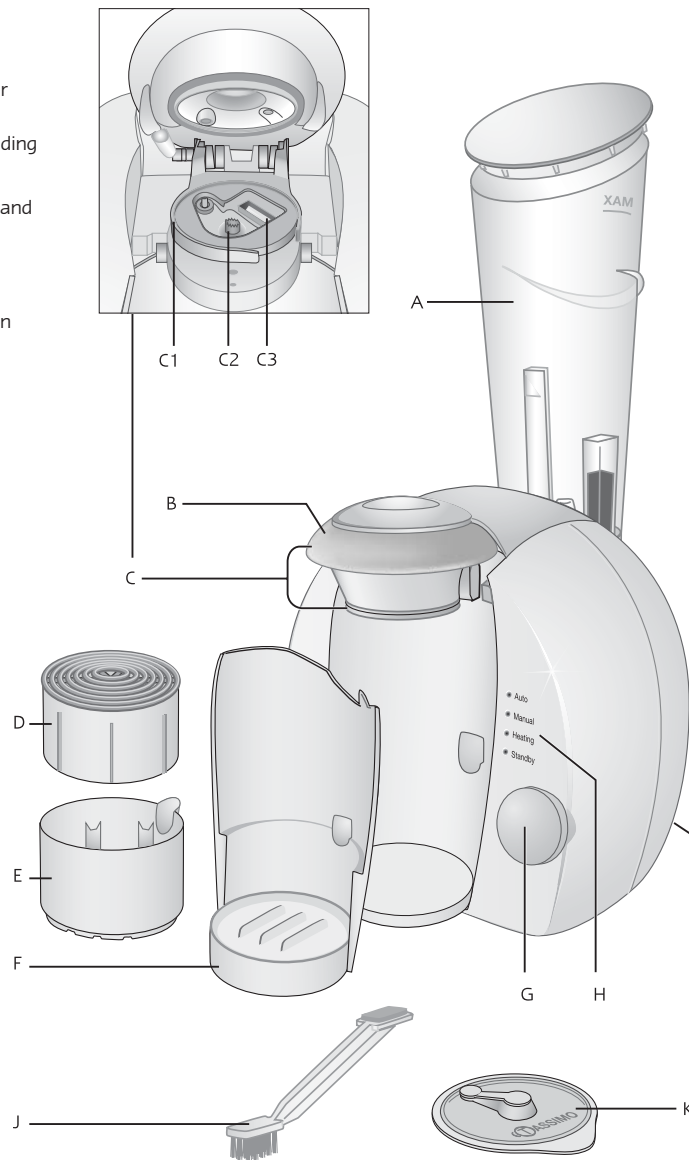

## Tassimo – Tips for the perfect cup

### Fresh Water

For best results, always use fresh, cold water. Fresh water allows the flavours to better unfold.

### T-DISCS

T-DISCS can be stored in their carton dispenser or if you prefer, you can transfer them to another container. Whilst you should always store your T-DISCS in a cool, dry place, it is not necessary to keep them in the refrigerator. Do not keep T-DISCS in the freezer. If unopened, your T-DISCS are good until the 'best before date' on the outer package.

### Cups and Mugs

The Tassimo machine will accommodate most of your favourite cups and mugs. Use the higher level of the **adjustable cup stand** for espresso cups and the lower level for most other cups. For larger mugs, you can also temporarily remove both the **drip tray** and the **cup stand**; however, these should be replaced right after brewing. Always keep the **splashback** in place while brewing.

To avoid spilling over, please ensure that your cup is the right size for the drink you are making. These are recommended cup sizes:

Espresso	75 ml
Cappuccino	200 ml
Coffee, Caffè crema, Chocolate* and Tea	280 ml

### Maintenance

You must regularly clean and descale your Tassimo machine to ensure best results (see sections "Cleaning" and "Descaling"). For cleaning and descaling purposes, a reusable **cleaning disc** is provided with the machine. Please keep it in a safe place for use as required.

# Preparing your machine for use

## PLEASE NOTE:

- This appliance is intended for household use only.
- Place the appliance on a dry, flat and fixed surface and keep it out of reach of children.
- Never use warm water, sparkling water or milk to fill the water container.
- Never open the **brew mechanism** during brewing. In "Auto Mode", always wait for the indicator light to move from *AUTO* to *MANUAL* before opening the **brew mechanism**. In "Manual Mode", take your finger off the **start/stop button** and wait until the machine has stopped before opening the **brew mechanism**.
- For some drinks, the brew cycle includes a 10 second pause after the initial influx of water. This pause is normal and allows the water to fully saturate the product before brewing continues.
- If during brewing you can hear the machine running but no drink is produced, stop the cycle by pressing and releasing the **start/stop button**. Open the **brew mechanism** carefully and slowly, and discard the T-DISC. Try again with a fresh T-DISC.
- After 10 minutes of non-use, the *STANDBY* light will illuminate. If you are not going to use your machine for an extended period, turn it off using the **on/off switch**.
- Braun electric appliances meet applicable safety standards. Repairs on electric appliances (including cord replacement) must only be carried out by authorised Braun service centres. Faulty, unqualified repair work may cause accidents or injury to the user.
- This machine is not suitable for use at altitudes above 2000 metres.



## IMPORTANT

**Before using your Tassimo machine for the first time, you must prepare it by following the procedure below.** Your Tassimo machine comes with a **cleaning disc** to use for rinsing and descaling the machine.

- 1** Rinse the **water container**, fill it to "max" with fresh cold water and place it on the machine. Check that the water container is inserted in the slot of the back of the machine. Connect the machine to the electrical supply and press the **on/off switch** located on the back of the machine. All the indicator lights will flash. Place a large cup (at least 200ml) on the **adjustable cup stand**.
- 2** Open the **brew mechanism**, position the **cleaning disc** on the **T-DISC holder**, bar code facing down. Firmly close the **brew mechanism** by pressing the **clamp** down until it shuts.
- 3** Wait five seconds then press and release the **start/stop button** to start the machine. You will hear the machine run for a short period to fill the internal water heater. When the machine stops running, the *STANDBY* light will illuminate.
- 4** Open the **brew mechanism** and close it again leaving the **cleaning disc** in place. The orange *HEATING* light will begin to flash. Wait about a minute until the green *AUTO* light illuminates then press and release the **start/stop button**. The machine will fill the cup with water. When the machine stops running, empty the cup and place it back on the **adjustable cup stand**. Repeat this step in its entirety.
- 5** Open the **brew mechanism** and remove the **cleaning disc**. The *HEATING* light will illuminate. Do not discard the cleaning disc after use – you will need it for flushing and descaling the appliance. Your machine is now ready to use.

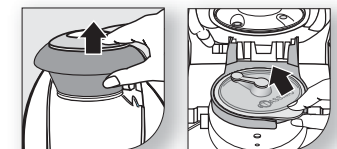
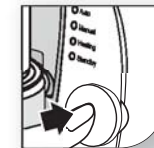
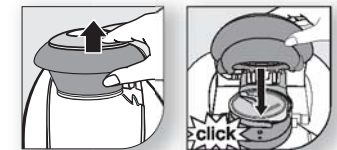
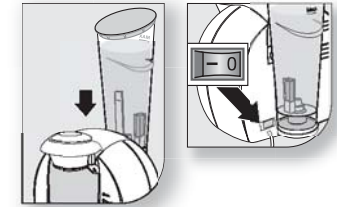

## How to use the machine – Auto Mode

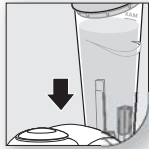

**1** Rinse and fill the **water container** with fresh cold water. Turn on the machine by pressing the **on/off switch**. Open the **brew mechanism**. Opening the **brew mechanism** will initiate the heating of the water and the **HEATING** light will flash.



**2** Place a clean cup on the **cup stand**, adjusting the height of the stand up or down so that the rim of the cup is close to the **brew mechanism**.

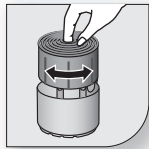

- To adjust the **cup stand**, insert your finger in the centre of the stand, lift and turn.
- To avoid **spilling over**, please choose the right sized cup for the drink you are making. See page 3 “Tips for the Perfect Cup”.

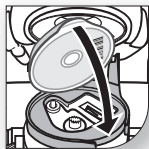

**3** Position your choice of T-DISC on the **T-DISC holder**, label facing down. Firmly close the **brew mechanism** by pressing the **clamp** down until it shuts. The **HEATING** light may flash again as the machine heats the water to the required temperature for your drink.

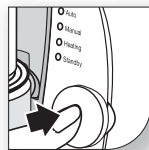

**4** When the **AUTO** light illuminates, press and release the **start/stop button**. Brewing will start automatically. There may be a short pause during brewing; this is normal. The **AUTO** light flashes throughout the brew cycle. When the machine has finished brewing, the indicator light will move from **AUTO** to **MANUAL** and then, after a delay of 30 seconds, to **HEATING**.

- When the indicator light moves to **MANUAL**, you can customise your cup as described in “Manual Mode” (See page 8).
- At any time during the “Auto Mode”, you can stop the brew cycle by pressing and releasing the **start/stop button**. The machine will stop and any remaining liquid inside the T-DISC will empty into the cup.

**5** Open the **brew mechanism**, remove the T-DISC and discard. Your drink is now ready to be enjoyed.

You can prepare the next beverage right away by repeating steps 2 – 5.

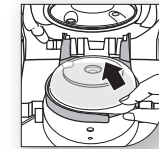

- Always remove the used T-DISC from the machine right after brewing. When removing the T-DISC, handle it by the thumb tab to avoid contact with heated areas.
- Please ensure that there is enough water in the **water container**. If the water level is too low, all the indicator lights will flash, signalling that the **water container** needs to be refilled.



## How to use the machine – Manual Mode

Whilst Tassimo is designed to make the optimal drink every time, your tastes may be different. With Tassimo, you can customise your cup by adjusting the amount of water and brewing time to suit your personal preferences.

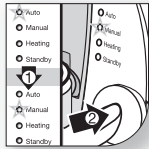

### For a milder flavour and a larger beverage

Follow steps 1-4 as described in "Auto Mode" (see page 6). When the indicator light moves from **AUTO** to **MANUAL**, simply press and hold the **start/stop button** to add more water.

Take your finger off the **start/stop button** when your drink has reached the desired intensity and size. Once you release the **start/stop button**, the brew cycle will stop, any remaining liquid inside the T-DISC will empty into the cup, and the indicator light will move back to **HEATING**.

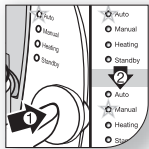

### For a stronger taste and a smaller beverage

Follow steps 1-3 as described in "Auto Mode". When the **AUTO** light illuminates, press and hold the **start/stop button** to directly move to Manual Mode. Continue holding the **start/stop button** until your beverage has reached the desired strength and size.

Once you release the **start/stop button**, the brew cycle will stop, any remaining liquid inside the T-DISC will empty into the cup, and the indicator light will move back to **HEATING**.



INDICATOR LIGHT	WHEN THE LIGHT IS FLASHING	WHEN THE LIGHT IS SOLID
AUTO	Machine is operating in Auto Mode.	Machine has recognised T-DISC and is ready to be operated in Auto Mode.
MANUAL	Machine is operating in Manual Mode.	Beverage has finished brewing and can now be customised. T-DISC is present but not recognised.
HEATING	Water is heating to required temperature.	Water is hot and the machine is ready to make a drink.
STANDBY		Machine has not been used for 10 minutes and is conserving energy. To operate the machine, simply insert a T-DISC and use normally.
ALL	The machine is not prepared for use. Error: check water level, check T-DISC.	



## Cleaning

**Regularly clean your Tassimo machine to ensure best results; a simple cleaning schedule (every two days) will keep your Tassimo machine working at full potential. Always unplug the appliance before cleaning. Never immerse the appliance in water. Never use abrasive cleaning products or scouring materials on any part of the Tassimo machine. All the removable pieces are dishwasher safe except the water container which must be hand washed.**

### Machine Exterior

- The outside of the machine should be wiped down as necessary with a damp soft cloth and washing up liquid. Always hand wash the **water container**.
- It is normal for the removable **drip tray** to collect water during the brewing process: regularly check the water level in the **drip tray** and empty it when it fills or at least once a day. The **drip tray**, **cup stand**, and **splashback** should be removed and cleaned; the **splashback** should be securely positioned before reinserting the **drip tray** and **cup stand**.

### Machine Interior and Brew Mechanism

- The inside of the **brew mechanism** should be wiped with a damp soft cloth and washing up liquid. A specially developed **cleaning tool** is included for cleaning the **bar code reading window**. Clean the **window** on a regular basis to ensure that the Tassimo machine can clearly read the bar code on the T-DISC.
- The **piercing unit** and **T-DISC holder** are easily removable and are dishwasher safe. Separate the piercing unit into two parts to clean it. The **piercing unit** can be quickly rinsed between beverages if desired.
- You can use the **cleaning disc** to flush the inside of the machine between drinks. Simply place the **cleaning disc** on the **T-DISC holder**, firmly close the **brew mechanism** and run clean water into an empty cup as described in "Preparing Your Machine for Use". This process should also be followed if the machine has been left unused for more than two days.
- After using a milk or chocolate\* T-DISC, it is recommended that you first rinse the **piercing unit** and then flush the machine using the **cleaning disc**.

## Descaling

**Descale your Tassimo machine every three months to keep it operating at full potential.**

- 1** Descaling products are widely available from stores selling coffee makers and espresso machines. Only use a product intended for descaling. Mix the descaling product directly in the **water container**, following the instructions provided on the descaling packaging. Replace the **water container** on the machine.
- 2** Place a large cup or mug on the cup stand, insert the **cleaning disc** barcode down and close the **brew mechanism**. When the AUTO light illuminates press and release the **start/stop button**. The brew cycle will fill the machine with descaling solution. Empty the cup and let the machine stand for 15 minutes.
- 3** Open the **brew mechanism** and close it again leaving the **cleaning disc** in place. When the AUTO light illuminates press and release the **start/stop button**. When the machine stops running, empty the cup and let the machine stand for 15 minutes. Repeat this step two more times for maximum descaling effectiveness. Discard the remaining descaling agent from the **water container**, rinse it thoroughly and refill with fresh cold water.
- 4** Open and close the **brew mechanism** again leaving the **cleaning disc** in place. When the AUTO light illuminates press and hold the **start/stop button** to flush water through the machine. The MANUAL light will illuminate. When the cup is full, release the **start/stop button** and empty the cup. Replace the cup and press and hold the **start/stop button** to continue flushing until the **water container** is empty. Refill the **water container** with fresh cold water and repeat this step.
- 5** Remove the **cleaning disc**, rinse and refill the **water container**. Your machine is now ready to use.

# Trouble shooting

In the table below are solutions to problems that may occur. If you do not find an appropriate solution, please refer to the “Tassimo careline” section.

PROBLEM	SITUATION	SOLUTION
All the <b>indicator lights</b> are flashing.	<ol style="list-style-type: none"> <li>1. Water level is too low.</li> <li>2. No T-DISC in machine.</li> <li>3. T-DISC is damaged.</li> <li>4. Machine not prepared for use.</li> <li>5. Internal machine fault.</li> </ol>	<ol style="list-style-type: none"> <li>1. Refill the <b>water container</b>.</li> <li>2. Place a T-DISC, label side down, on the <b>T-DISC holder</b> and close the <b>brew mechanism</b>.</li> <li>3. Clean the <b>bar code reading window</b> or replace the T-DISC.</li> <li>4. Follow the procedure "Preparing Your Machine for Use".</li> <li>5. Contact Tassimo careline.</li> </ol>
The machine will not move past <b>STANDBY</b> .	The <b>brew mechanism</b> may not be closed properly.	Make sure that a T-DISC is placed on the <b>T-DISC holder</b> and the <b>brew mechanism</b> is firmly closed.
The Auto Mode is not working.	Bar code reader may not be able to read the T-DISC label.	Clean the <b>bar code reading window</b> . Replace the T-DISC. You can still enjoy your preferred drink by using the Manual Mode.
My cup is overflowing.	Each drink has been formulated to produce the perfect amount of liquid. Be sure that you are using the right sized cup for your drink.	Ensure that you use the following recommended cup sizes: Espresso 75ml Cappuccino 200ml Coffee, Caffè crema, Chocolate*and Tea 280ml
My cup doesn't fit.	The <b>cup stand</b> is too close to the <b>brew mechanism</b> .	Try lowering the <b>cup stand</b> to fit your cup. You can also temporarily remove the <b>cup stand</b> and <b>drip tray</b> , leaving the <b>splashback</b> in place.



PROBLEM	SITUATION	SOLUTION
Liquid is splashing out of the cup.	Cup is placed too far away from the <b>brew mechanism</b> .	Adjust the height of the <b>cup stand</b> up to ensure that the cup is closer to the <b>brew mechanism</b> .
The machine is leaking from the <b>brew mechanism</b> .	<ol style="list-style-type: none"> <li>1. T-DISC is damaged or leaking.</li> <li>2. The <b>piercing unit</b> is not fitted properly.</li> </ol>	Press the <b>start/stop button</b> to stop the brew cycle. Slowly open the <b>brew mechanism</b> , remove the T-DISC, and clean the inside of the <b>brew mechanism</b> . Remove and refit the <b>piercing unit</b> .
The machine is leaking from the bottom.	<ol style="list-style-type: none"> <li>1. <b>Drip tray</b> is full of water.</li> <li>2. <b>Splashback</b> is not properly fitted.</li> </ol>	<ol style="list-style-type: none"> <li>1. Empty the <b>removable drip tray</b>.</li> <li>2. Remove and refit the <b>splashback</b>, <b>cup stand</b>, and <b>drip tray</b> back on the machine.</li> </ol>
My drinks are brewing shorter than usual.	The machine may require descaling.	Descale the machine following the "Descaling" procedure.
I have lost my <b>cleaning disc</b> .	A <b>cleaning disc</b> is needed to rinse and descale the machine.	Contact Tassimo careline.
My machine is not operating; there are no lights illuminated.	The electrical supply may not be connected properly.	Check that the machine is properly plugged into the electrical supply. Check the <b>on/off switch</b> at the back of the machine.





## Tassimo careline

**For information, questions, or locations of authorised  
Braun service centres nearest you, contact Tassimo:**

**Website:** [www.tassimo.com](http://www.tassimo.com)

**Phone:** 0800 0328833 (UK only)

**Mail:** Freepost SWC3320, Cheltenham, GL50 3ZZ

## Guarantee Regulations

We grant a 2-year guarantee on the product commencing on the date of purchase. Within the guarantee period we will eliminate, free of charge, any defects in the appliance resulting from faults in materials or workmanship, either by repairing or replacing the complete appliance as we may choose.

This guarantee extends to every country where this appliance is supplied by Braun.

This guarantee does not cover: damage due to improper use, normal wear or use as well as defects that have a negligible effect on the value or operation of the appliance. The guarantee becomes void if repairs are undertaken by unauthorised persons and if original Braun parts are not used.

To obtain service within the guarantee period, hand in or send the complete appliance with your sales receipt to an authorised Braun Customer Service Centre.

This product conforms to the EMC-Directive 89/336/EEC  
and to the Low Voltage Regulation 73/23/EEC.



**TASSIMO**

THE ART OF THE PERFECT CUP

© Registered Trademark, ™ Trademark application pending

**TYPE 3107**